

BUILDING CODE

**MARIT**

WALL LOG (mm): 45

SIZE (mm): 4000x4000

## ISOMETRIC BEAMS CONSTRUCTION

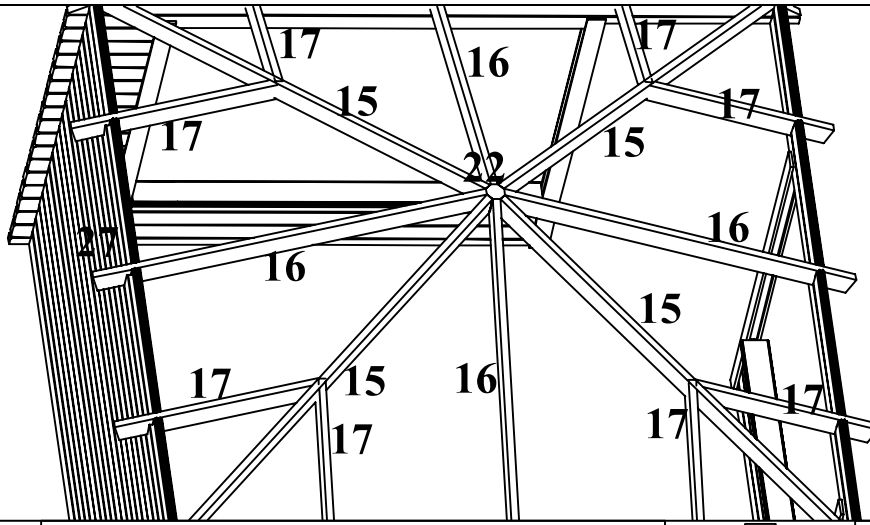

15	Beam			2967	120	40	4
16	Beam			2163	120	40	4
17	Beam			1210	120	40	8
22	Beam						1

## ISOMETRIC ROOF'S CONSTRUCTION

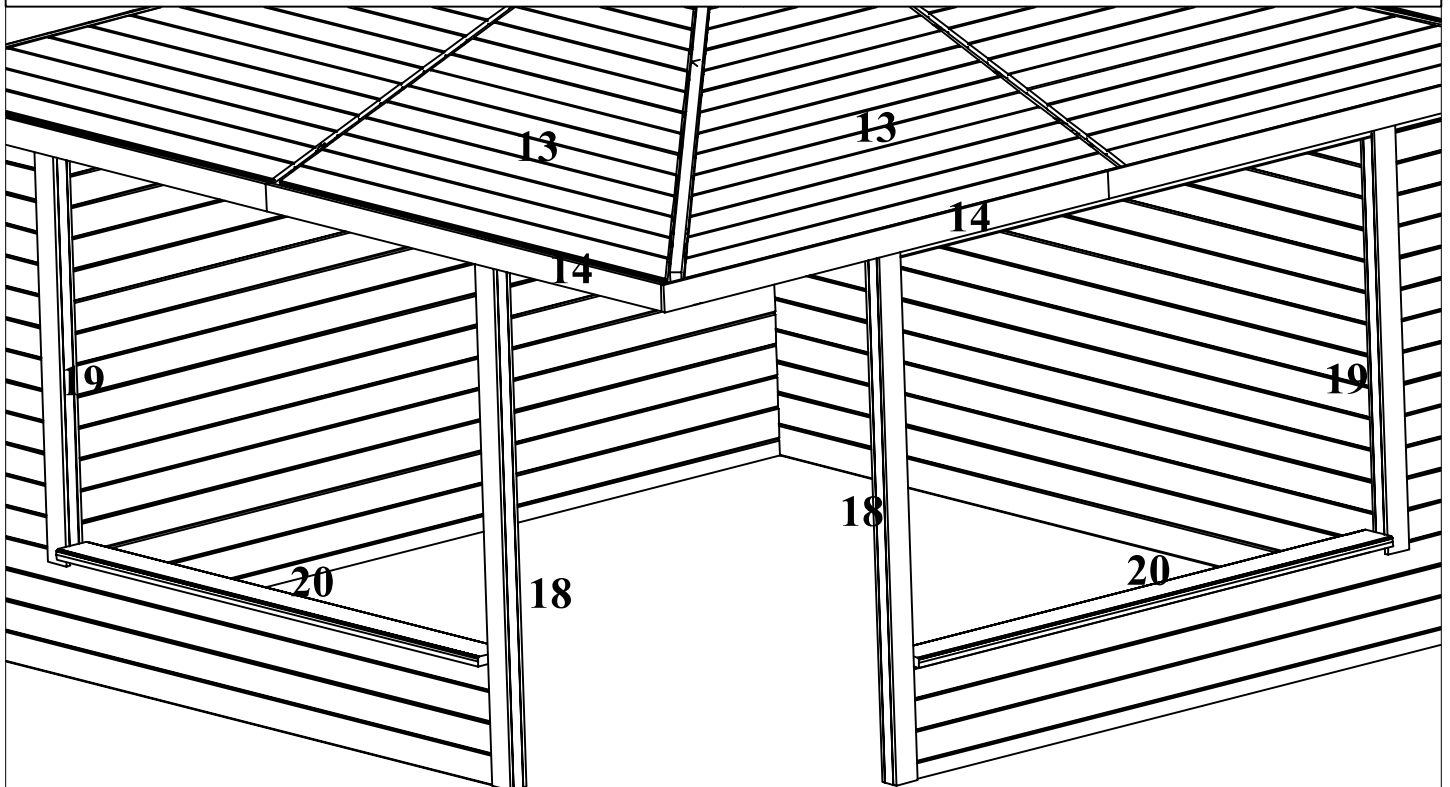

13	Roof board				110	19	8
14	Roof cover fixture			4400	100	16	4
18	Column/support			1955	100	77	2
19	Column/support			1485	100	77	2
20	Sill/support			2240	110	26	2

PACKAGE NR.:

MNFCT. ORDER NR.:

**CONTROL 1**

**CONTROL 2**

PAGE/PAGES:

**8/8**

SIGNATURE

SIGNATURE

BUILDING CODE

**MARIT**

WALL LOG (mm): 45

SIZE (mm): 4000x4000

## HEIGHT VIEW

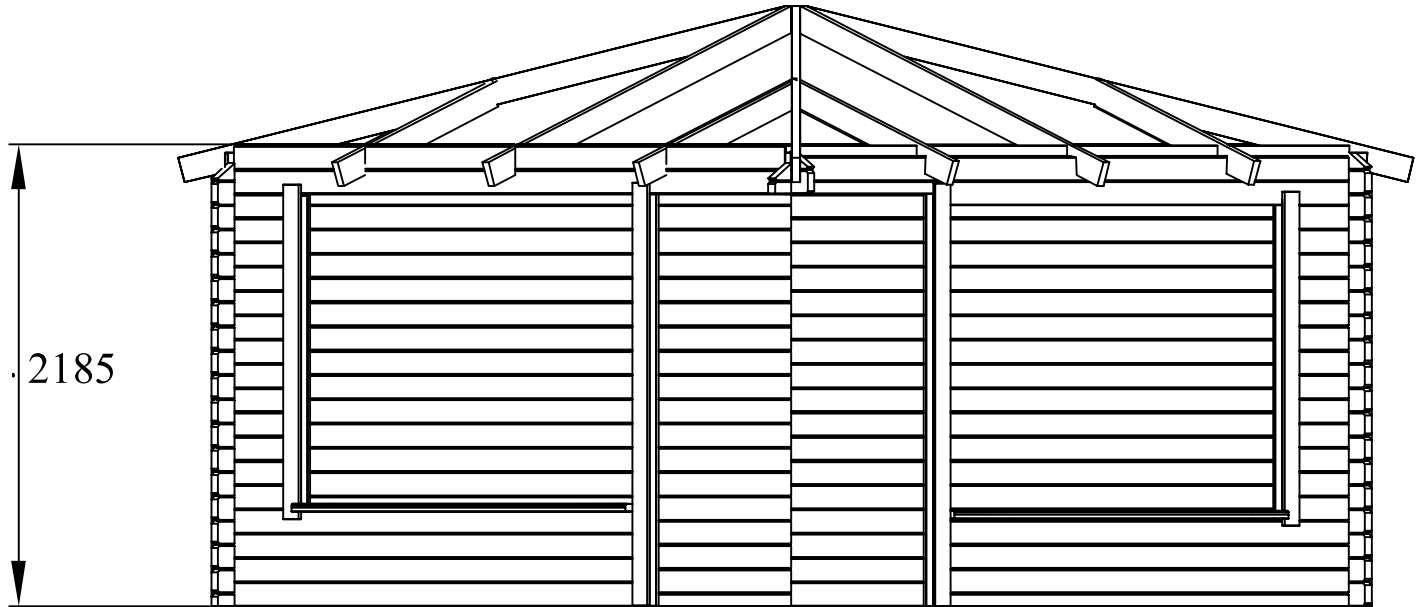

## PEDESTAL VIEW

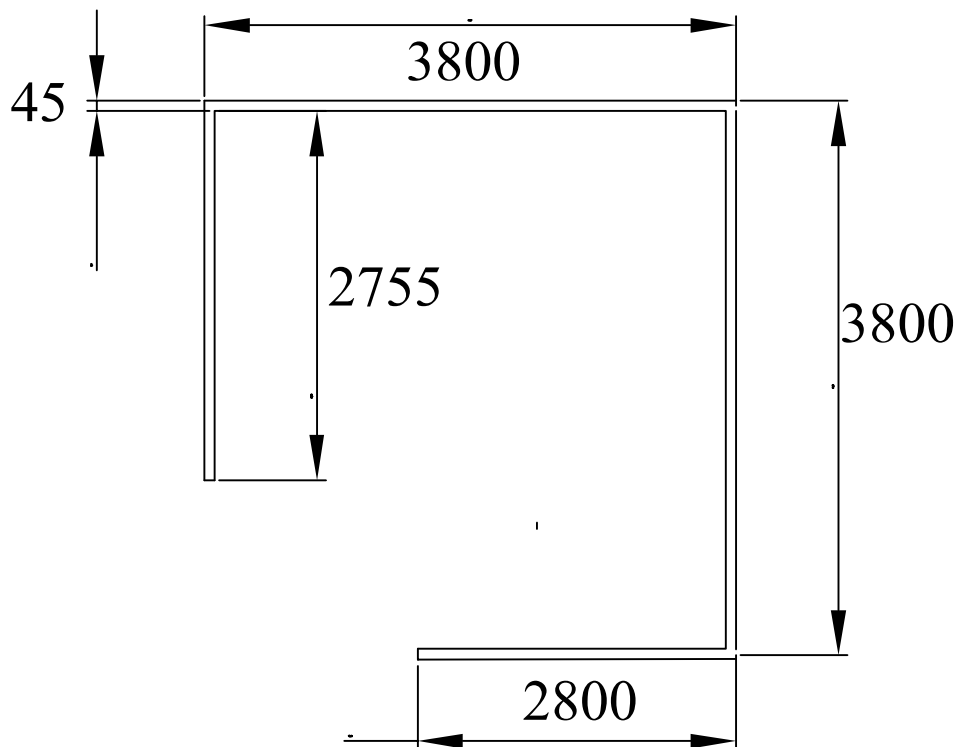

PACKAGE NR.:

MNFCT. ORDER NR.:

**CONTROL 1**

**CONTROL 2**

PAGE/PAGES:

**7/8**

SIGNATURE

SIGNATURE

BUILDING CODE

**MARIT**

WALL LOG (mm): 45

SIZE (mm): 4000x4000

**CONSTRUCCION 3**

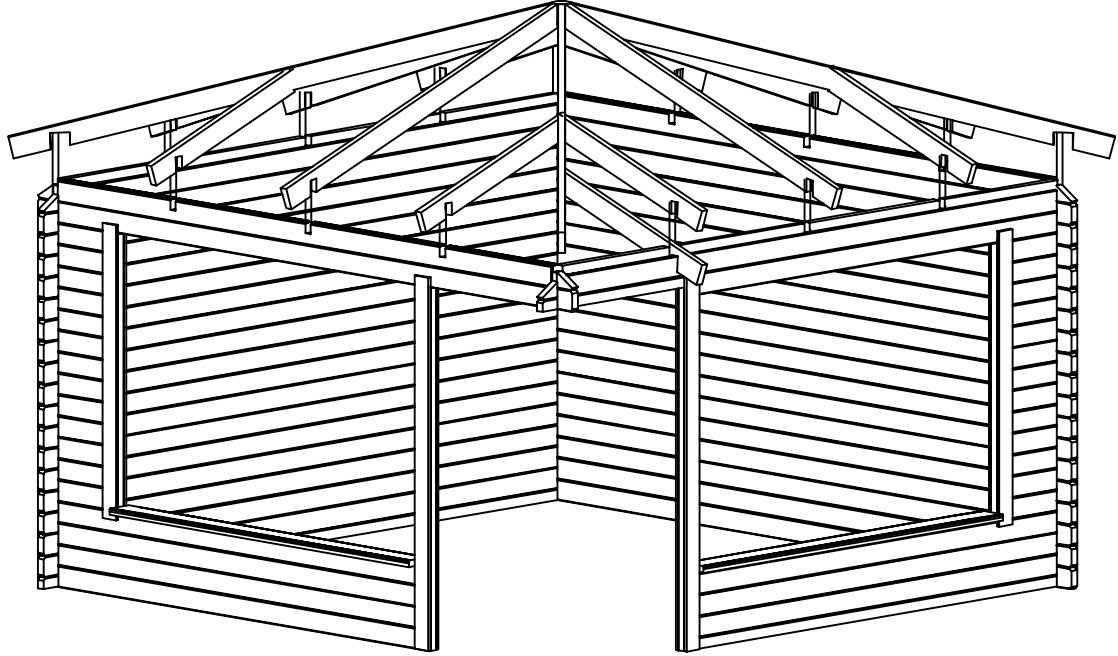

**CONSTRUCCION 4**

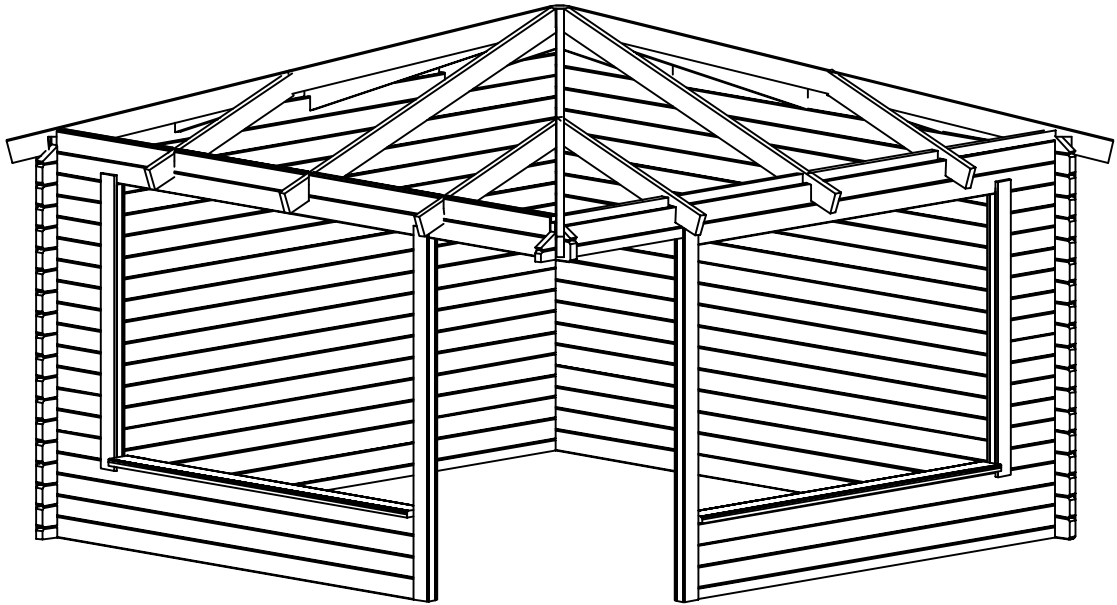

PACKAGE NR.:

MNFCT. ORDER NR.:

**CONTROL 1**

**CONTROL 2**

SIGNATURE

SIGNATURE

PAGE/PAGES:

**6/8**

BUILDING CODE

**MARIT**

WALL LOG (mm): 45

SIZE (mm): 4000x4000

## CONSTRUCCION 1

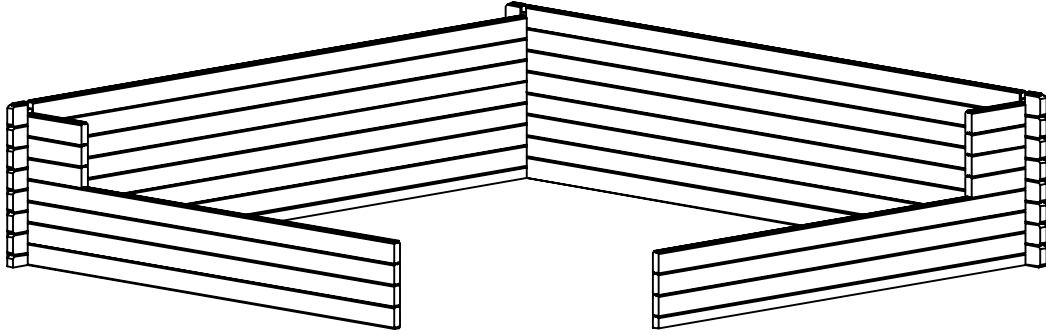

## CONSTRUCCION 2

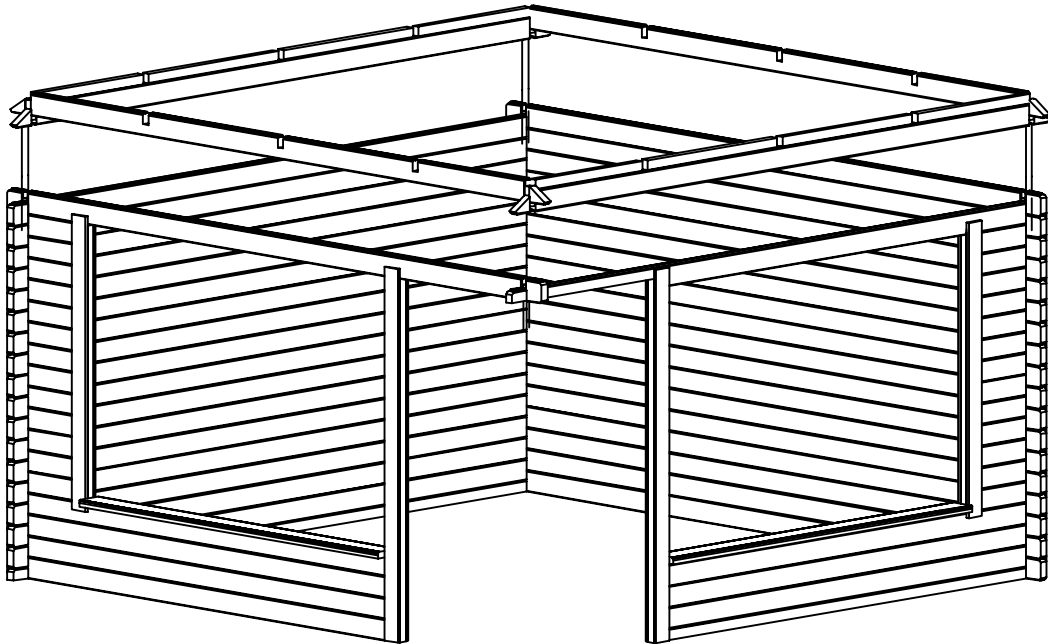

PACKAGE NR.:

MNFCT. ORDER NR.:

**CONTROL 1**

**CONTROL 2**

SIGNATURE

SIGNATURE

PAGE/PAGES:

**5/8**

BUILDING CODE

# MARIT

WALL LOG (mm): 45

SIZE (mm): 4000x4000

## LEFT VIEW

Ⓒ

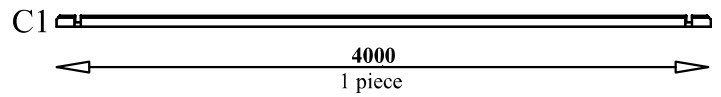
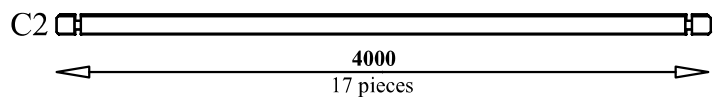
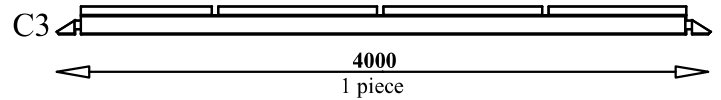
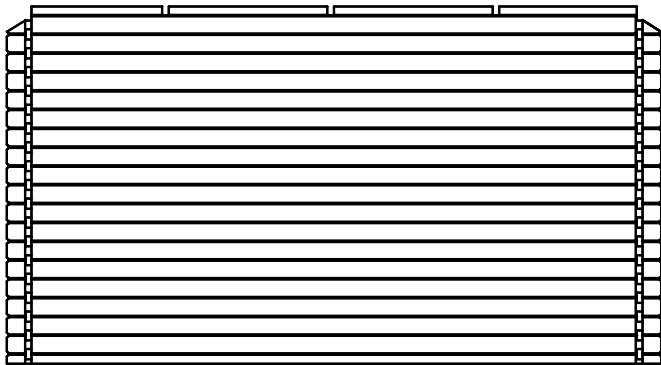

## RIGHT VIEW

Ⓓ

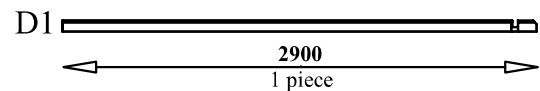
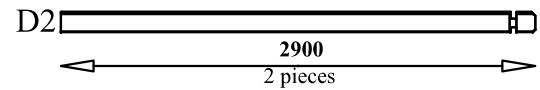
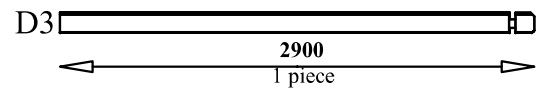
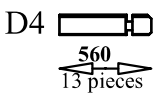
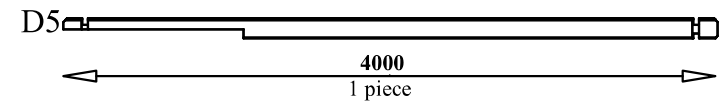
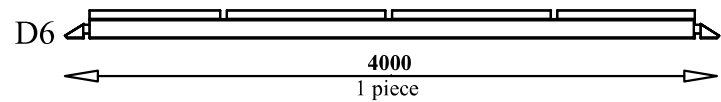
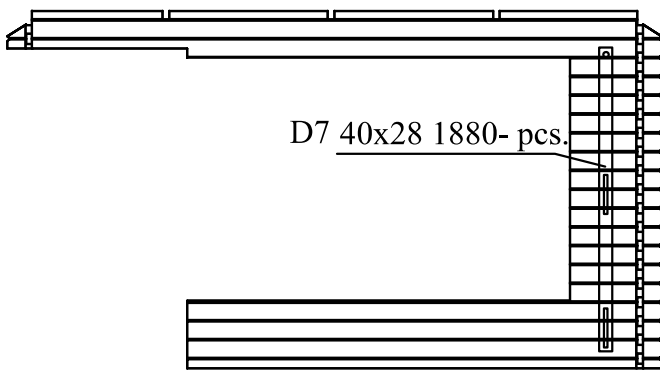

PACKAGE NR.:

MNFCT. ORDER NR.:

**CONTROL 1**

**CONTROL 2**

SIGNATURE

SIGNATURE

PAGE/PAGES:

# 4/8

BUILDING CODE

# MARIT

WALL LOG (mm): 45

SIZE (mm): 4000x4000

## FRONT VIEW

(A)

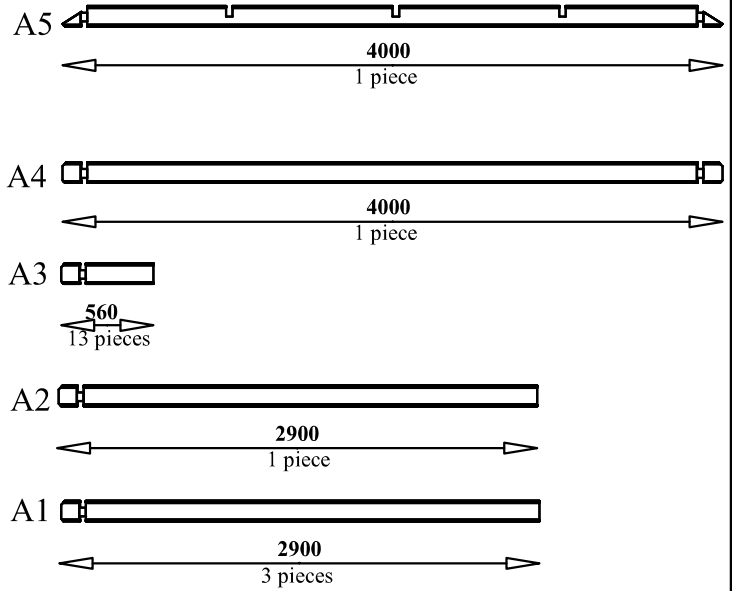
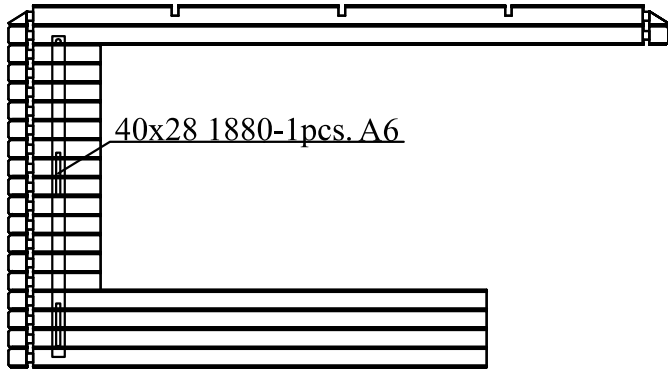

## BACK VIEW

(B)

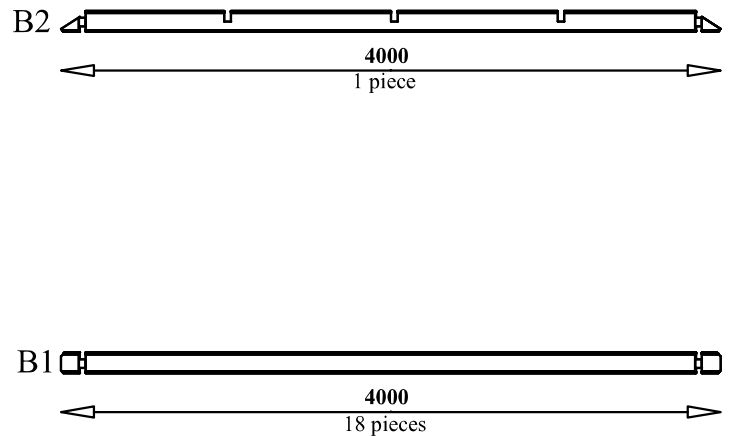
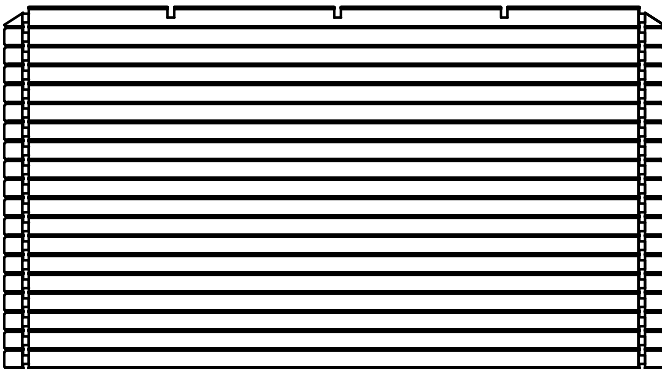

PACKAGE NR.:

MNFACT. ORDER NR.:

**CONTROL 1**

**CONTROL 2**

SIGNATURE

SIGNATURE

PAGE/PAGES: **3/8**

BUILDING CODE

**MARIT**

WALL LOG (mm): 45

SIZE (mm): 4000x4000

# ISOMETRIC VIEW

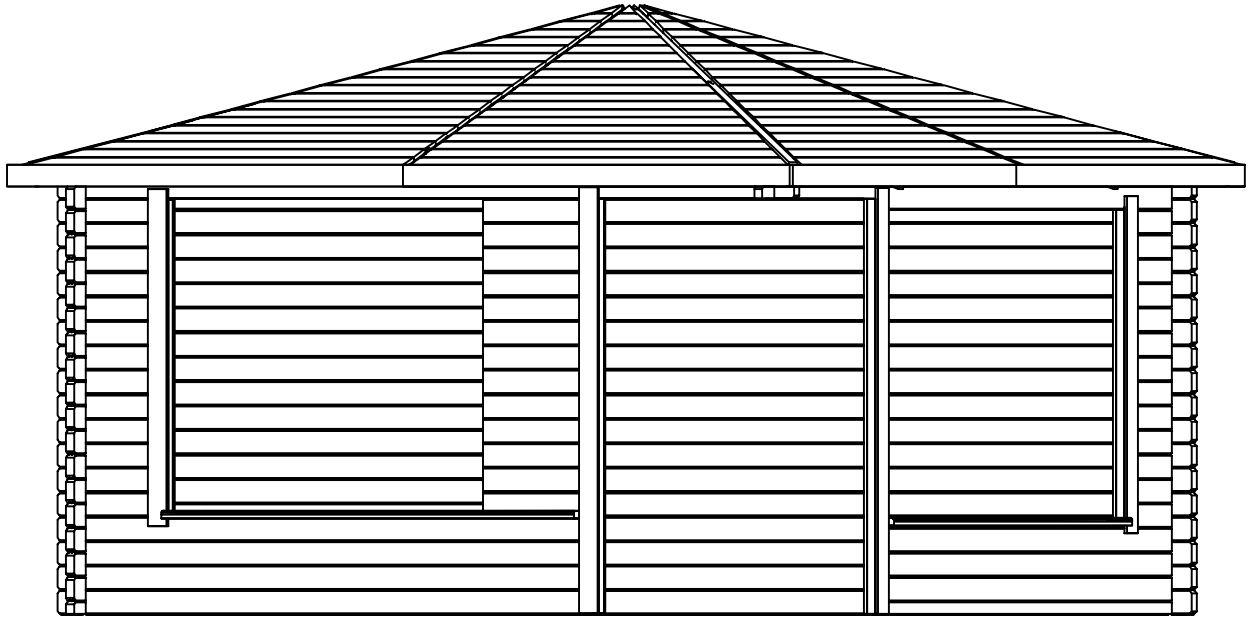

# TOP VIEW

A-FRONT  
B-BACK  
C-LEFT  
D-RIGHT

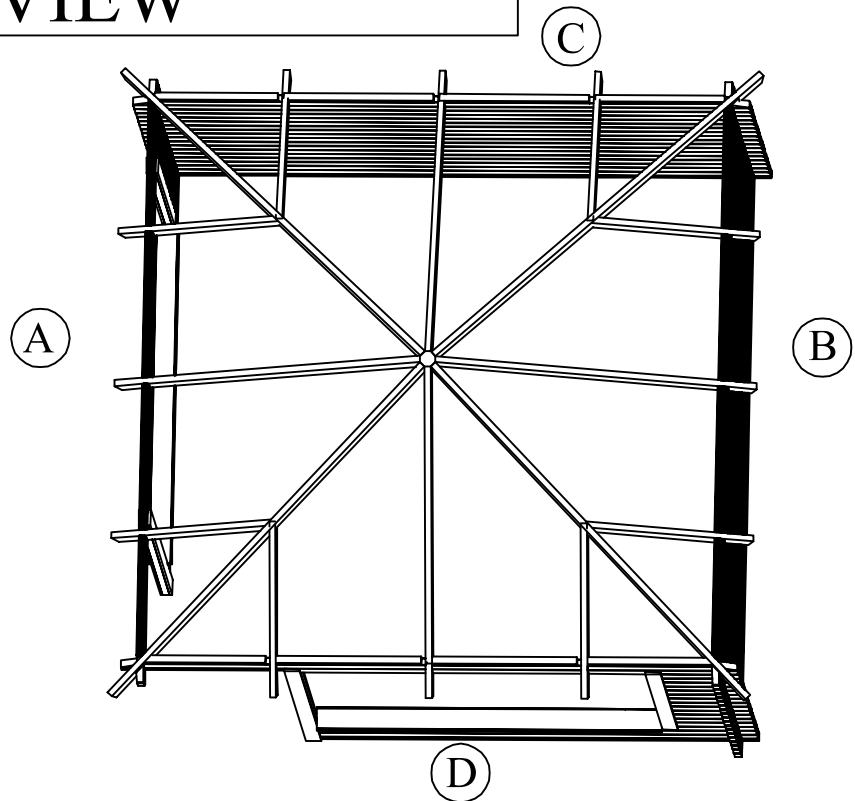

PACKAGE NR.:

MNFCT. ORDER NR.:

**CONTROL 1**  
SIGNATURE

**CONTROL 2**  
SIGNATURE

PAGE/PAGES: **2/8**

BUILDING CODE

# MARIT

WALL LOG (mm): 45

SIZE (mm): 4000x4000

## COMPONENT SPECIFICATION

NUMBER	COMPONENT FUNCTION	COMPONENT CODE	VIEW	SIDE VIEW	DIMENSIONS (mm)			QUANTITY (psc.)
					LENGHT	WIDTH	THICKNESS	
1	Wall board	A1			2900	115	45	3
2	Wall board	A2			2900	115	45	1
3	Wall board	A3			560	115	45	13
4	Wall board	A4, B1, C2			4000	115	45	36
5	Wall board	A5, B2			4000	115	45	2
6	Wall board	C3, D6			4000	115	45	2
7	Wall board	D2			2900	115	45	2
8	Wall board	D3			2900	115	45	1
9	Wall board	D4			560	115	45	13
10	Wall board	D5			4000	115	45	11
11	Wall board	C1			4000	115	45	1
12	Wall board	D1			2900	115	45	1
13	Roof board						19	8
14	Roof cover fixture				4400	120	16	4
15	Beam				2967	120	40	4
16	Beam				2163	120	40	4
17	Beam				1210	120	40	8
18	Column/support				1955	100	77	2
19	Column/support				1485	100	77	2
20	Sill/support				2240	110	26	8
22	Octagon							1
23	Beam	A6, D7			1880	40	28	2
24								
25								
26								
27								
28								
29								
30								

PACKAGE NR.:

MNFCT. ORDER NR.:

CONTROL 1

CONTROL 2

PAGE/PAGES:

# 1/8

SIGNATURE

SIGNATURE